

PS-22E08XX

PUSH SWITCH

G-Switch P/N

N=NO LOCK
L=LOCK

A=黑色
B=红色
C=蓝色
D=其它

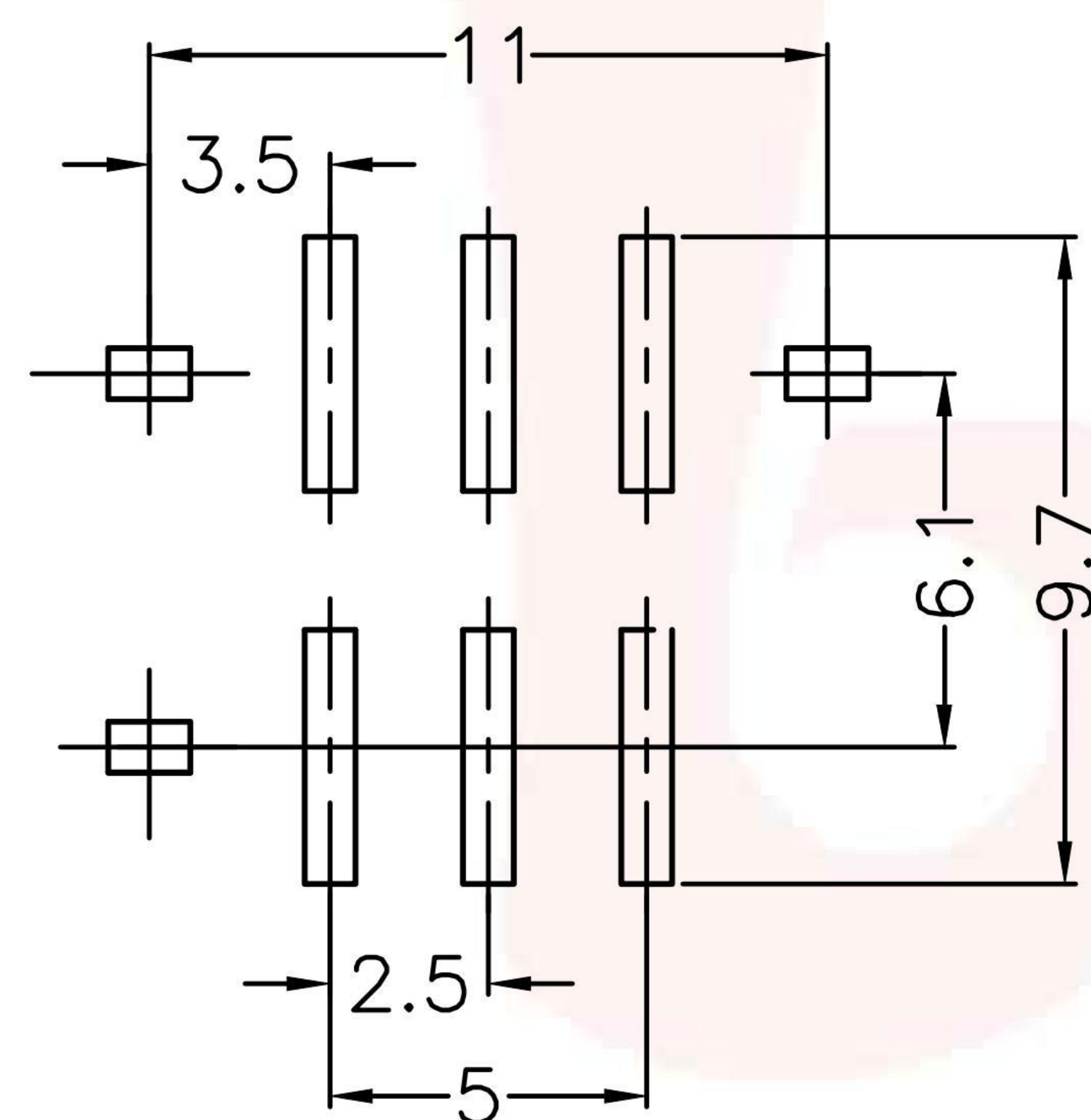

**P.C.B LAYOUT
BOTTOM VIEW**

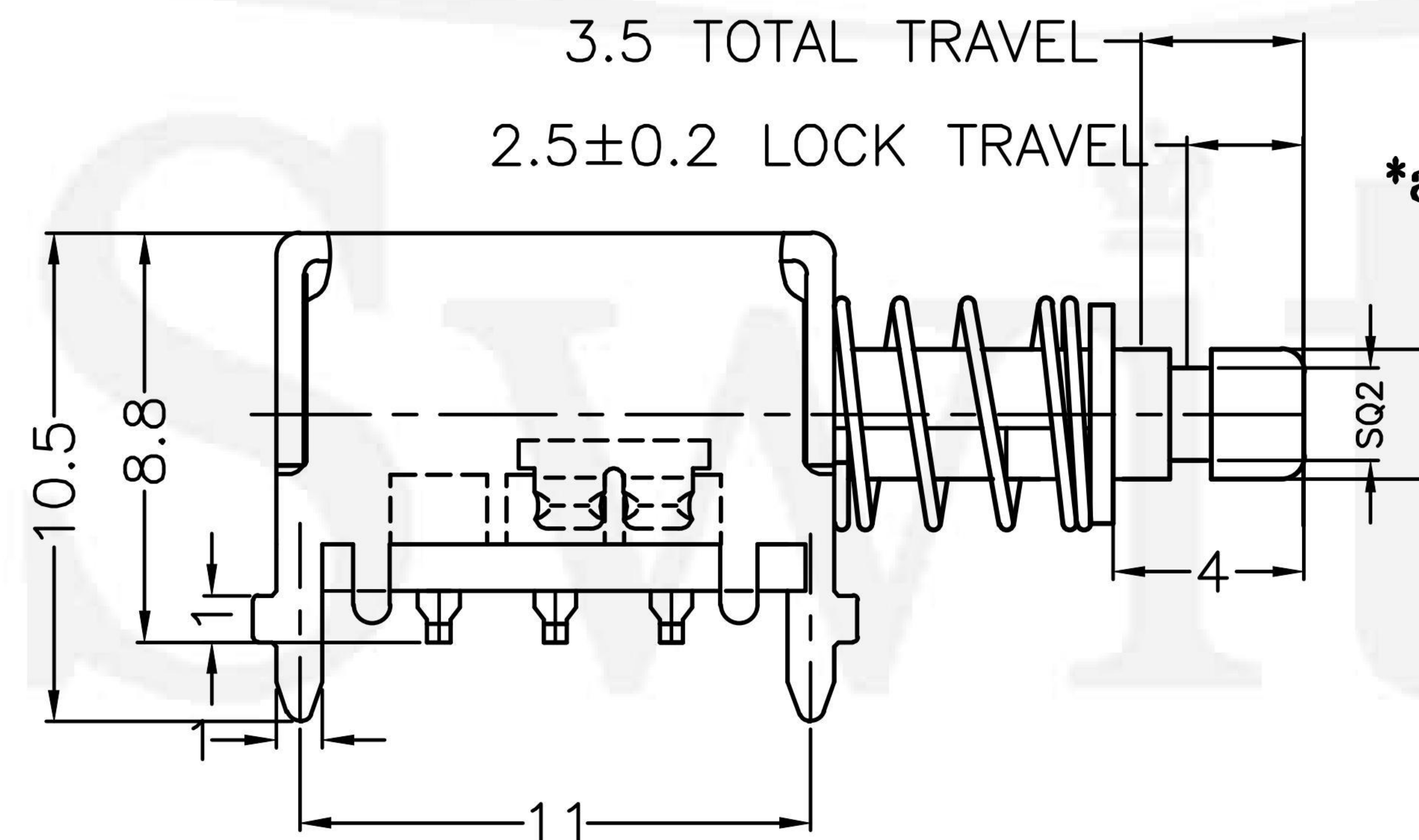

G-Switch Specification:

Electrical Specifications: 0.5A 30VDC
 Contact Resistance : ≤100mΩ
 Insulation Resistance: ≥100MΩ DC125V
 Withstand Voltage: AC125V 1 minute
 Operating Temperature: -25°C~+65°C
 Storage Humidity: ≤85%RH
 Electrical Life: 10,000
 Mechanical Life: 100,000

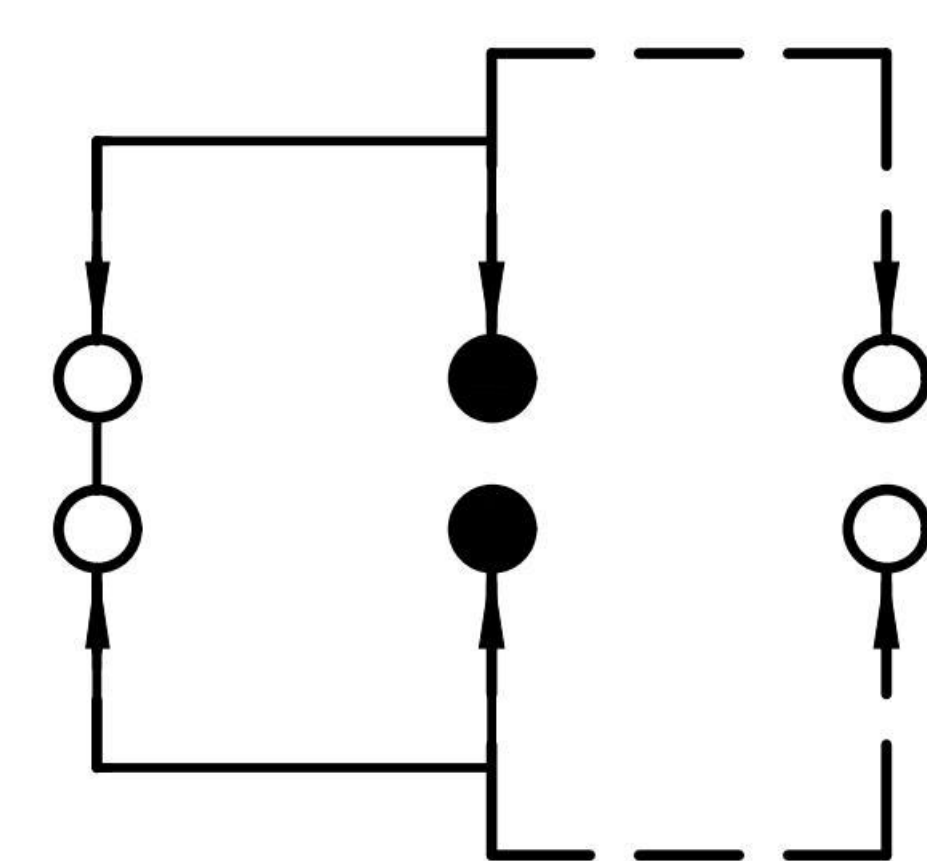

SCHEMATIC (NON-SHORTING)



G-Switch Electronic (HongKong) CO.,Ltd.

Unless otherwise specified, Tolerance:
 X. ±0.30
 X.x ±0.20
 X.xx ±0.15
 X.xxx ±0.10
 Angles ±3°

DESIGN Yvette Chen	DATE 2019.05.29
CHECKED	DATE
APPROVED	DATE
http://www.dg-switch.com	
TEL:0769-82388879	

Molde code:		
PS-22E08XX		
REV.: X1	SCALE: 4:1	UNIT: mm
SIZE: A4	SHEET: 1/1	