

GT-TA114X-HXXX-LX

G-SWITCH

Operating Force

- A=160gf
- B=250gf
- C=100gf

Switch Height (mm)

- H043=4.3mm
- H073=7.3mm
- H080=8.0mm
- H085=8.5mm

Switch lifetime (Force)

L100=10,000,000 Cycles

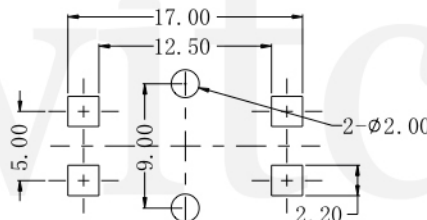
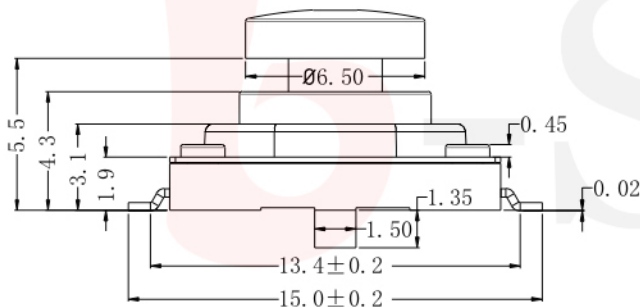

P.C.B LAND DIMENSION

G-Switch Specification:

Operating temperature range : -30°C to +85°C
 Rating : 50mA.12V DC
 Insulation resistance: : 100MΩ min.100V DC
 Dielectric strength : 250V AC for 1 min
 Contact resistance: : 100m Ω max.
 Travel:0.30±0.1mm

Circuit Diagram

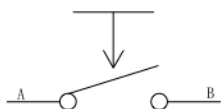

	G-Switch Electronic (HongKong) CO.,Ltd.		
	DESIGN FengFengChen CHECKED APPROVED http://www.dg-switch.com TEL:0769-82388879	DATE 2020.05.29 DATE DATE http://www.dg-switch.com TEL:0769-82388879	Molde code: GT-TA114X-HXXX-LX REV.: X1 SCALE: 4:1 UNIT: mm SIZE: A4 SHEET: 1/1

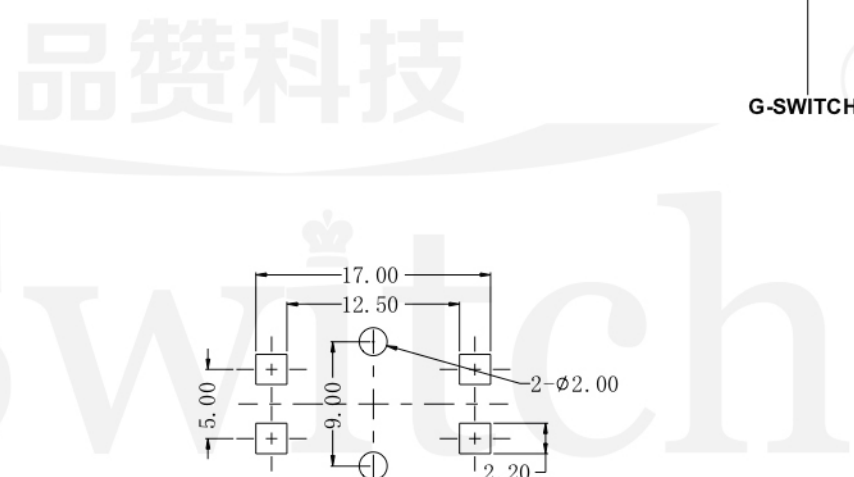

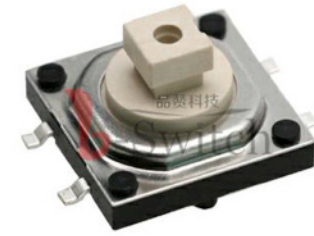
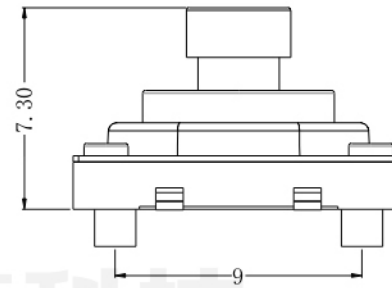
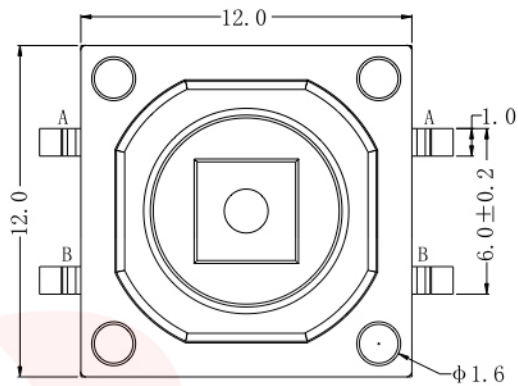

GT-TC114X-HXXX-LX

G-SWITCH

Operating Force

A=160gf
B=250gf
C=100gf

Switch Height (mm)
H073=7.3mm

Switch lifetime (Force)
L100=10,000,000 Cycles

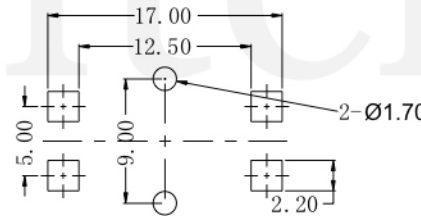
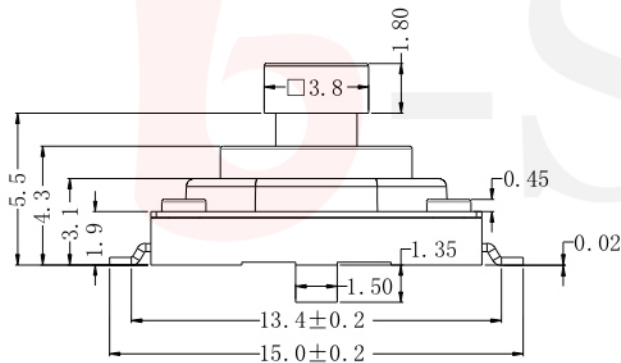
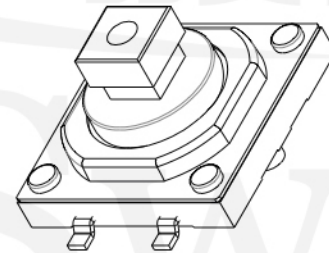

P.C.B LAND DIMENSION

G-Switch Specification:

Operating temperature range : -30°Cto+85°C
 Rating : 50mA.12V DC
 Insulation resistance: : 100MΩ min.100V DC
 Dielectric strength : 250V AC for 1 min
 Contact resistance: : 100m Ω max.
 Travel:0.30±0.1mm

Circuit Diagram

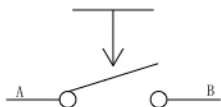

	G-Switch Electronic (HongKong) CO.,Ltd.		
	DESIGN FengFengChen	DATE 2020.05.29	Molde code: GT-TC114X-HXXX-LX
	CHECKED	DATE	
	APPROVED	DATE	REV.: X1 SCALE: 4:1 UNIT: mm SIZE: A4 SHEET: 1/1
Unless otherwise specified, Tolerance: X. ±0.30 X.x ±0.20 X.xx ±0.15 X.xxx ±0.10 Angles ±3°	http://www.dg-switch.com TEL:0769-82388879		