

1

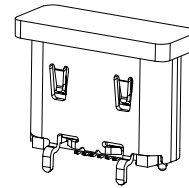

2

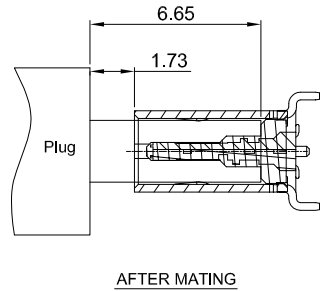
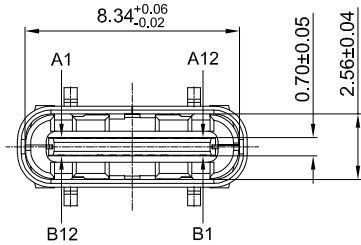
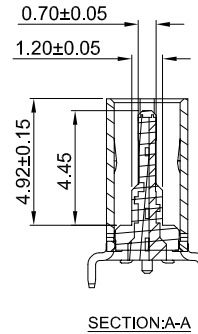
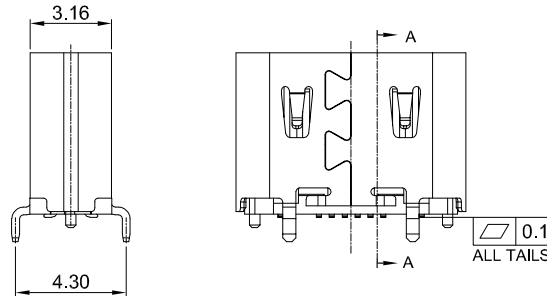
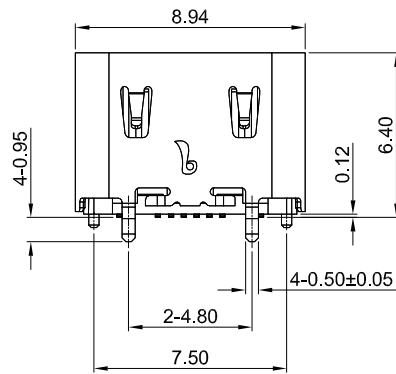

G-Switch USB-C Specification:

- 1.Current rated: 5A on vbus/1.25A on vconn/0.25A on other
- 2.Withstanding voltage: 100V AC/minute
- 3.Contact resistance: 40mΩ Max
- 4.Insulation resistance: 100MΩ Min
- 5.Operating temperature: -40°C ~ +85°C
- 6.Mating force: 5N~20N
- 7.Unmating force: 8N~20N
- 8.Durability cycle: 10,000 cycles
- 9.Compliant with: IEC62680-1-3

品赞电子(东莞)有限公司

品赞电子(东莞)有限公司

4

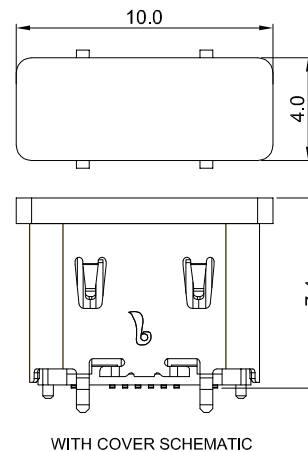
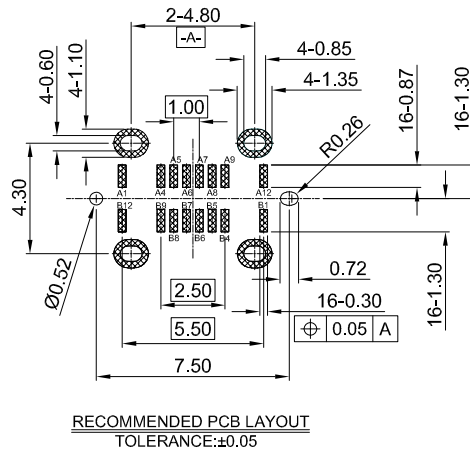
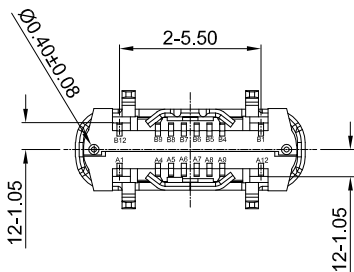

A1	A2	A3	A4	A5	A6	A7	A8	A9	A10	A11	A12
GND			VBUS	CC1	D+	D-	SBU1	VBUS			GND
First			First	Second	Second	Second	Second	First			First
B12	B11	B10	B9	B8	B7	B6	B5	B4	B3	B2	B1
GND			VBUS	SBU2	D-	D+	CC2	VBUS			GND
First			First	Second	Second	Second	Second	First			First

5

1	SHELL	STAINLESS STEEL304	Ni 30u" Min PLATED
2	MID PLATE	STAINLESS STEEL301	Ni 30u" Min PLATED
3	HOUSING	HIGH TEMPERATURE PLASTIC	BLACK UL 94 V-0
4	TERMINALS	COPPER ALLOY C1815	Au1u" Min PLATING ON CONTACT AREA
NO.	PARTS	MATERIAL	REMARKS

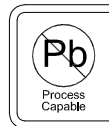

SCALE: 1:1 UNIT: mm
SIZE: A4

Unless otherwise General Tolerance:
X..x ±0.30
X..xx ±0.20
X..xxx ±0.10
X..x" ±3°
X..xx" ±2°

Title: Vertical Type-c 16P Female SMT H=6.4mm

Molde Code: GT-USB-9055BA

DRAWN	CHECKED	APPROVED	DATE
Xla	Chen	Chen	2023,02,01



REV: A0 SHEET: 1/1

A

B

D

E

5