

GT-A1504 H M-1 XX X 01

G-Switch
Series No
Connector
M-Male
Housing Colour
 W-Withe
Pin Q' PY
 02-16
Row NO
 1-Single Row

G-Switch Specification:

- 1.Current rated: 2A AC/DC
- 2.Voltage rating: 100V AC/DC
- 3.Withstanding voltage:500V AC
- 4.Contact resistance: 20mΩ max.
- 5.Insulation resistance: 500MΩ min
- 6.Durability cycle: 30Cycles
- 7.Removal force: 1.0kg/Pin min
- 8.Operating temperature range: -25°C ~ +85°C

Ordering Information:

Circuit	Dimension(mm)		Circuit	Dimension(mm)	
	A	B		A	B
02	5.00	--	10	16.80	13.50
03	6.30	3.00	11	18.30	15.00
04	7.80	4.50	12	19.80	16.50
05	9.30	6.00	13	21.30	18.00
06	10.80	7.50	14	22.80	19.50
07	12.30	9.00	15	24.30	21.00
08	13.80	10.50	16	25.80	22.50
09	15.30	12.00	--	--	--

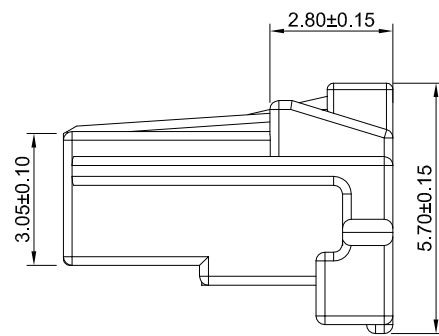
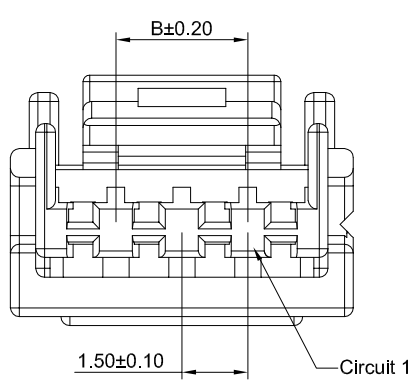

SCALE: 1:1 UNIT: mm
 SIZE: A4

Unless otherwise
 General Tolerance:
 X ±0.40
 X.x ±0.30
 X.xx ±0.20
 X° ±5°
 X.x° ±3°

Title: Housing 1.50mm Pitch Single Row Connector

Molde Code: GT-A1504HM-1XXX01

DRAWN	CHECKED	APPROVED	DATE
Hu	Hu	Chen	2021.10.20



REV: A0 SHEET: 1/2

NO.	PART NAME	MATERIAL	REMARK
1	HOUSING	PBT,94V-0	Withe



1

2

3

4

5

A

A

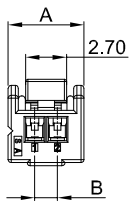
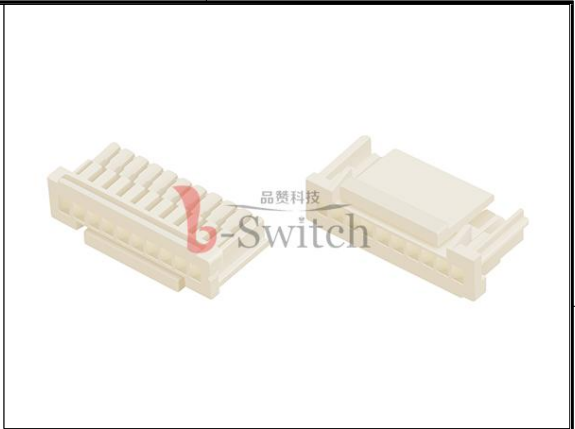

2PIN

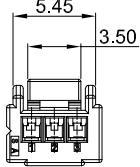

3PIN

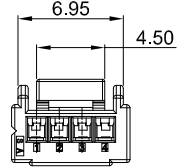

4PIN

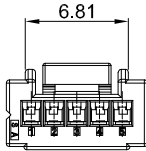

5PIN

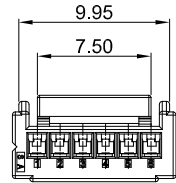

6PIN

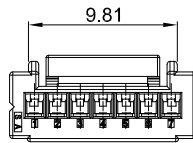

7PIN

B

B

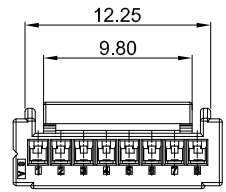

8PIN

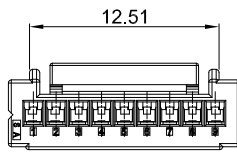

9PIN

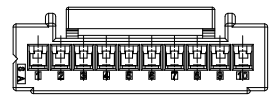

10PIN

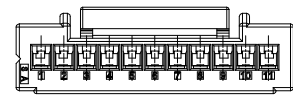

11PIN

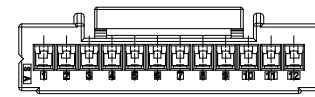

12PIN

C

C

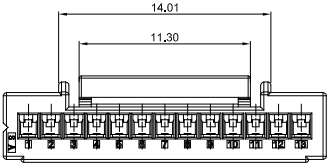

13PIN

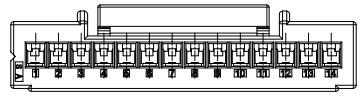

14PIN

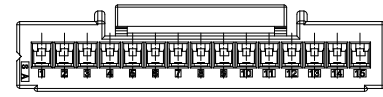

15PIN

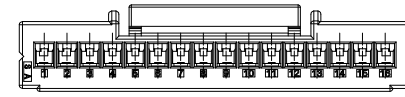

16PIN

D

D

E

E

1	HOUSING	PBT,94V-0	Withe
NO.	PART NAME	MATERIAL	REMARK



SCALE: 1:1 UNIT: mm
 SIZE: A4

Unless otherwise
 General Tolerance:
 X ±0.40
 X.x ±0.30
 X.xx ±0.20
 X* ±5°
 X.x° ±3°

Title: Housing 1.50mm Pitch Single Row Connector

Molde Code: GT-A1504HM-1XXX01

DRAWN	CHECKED	APPROVED	DATE
Hu	Hu	Chen	2021.10.20



REV: A0 SHEET: 2/2

1

2

3

4

5