

A

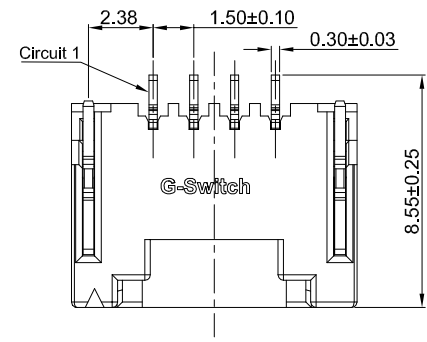

- G-Switch Specification:**
- 1.Current rated: 2A AC/DC
 - 2.Voltage rating: 100V AC/DC
 - 3.Withstanding voltage:500V AC
 - 4.Contact resistance: 20mΩ max.
 - 5.Insulation resistance: 500MΩ min
 - 6.Durability cycle: 30Cycles
 - 7.Removal force: 1.0kgf/Pin min
 - 8.Operating temperature range: -25°C ~ +85°C

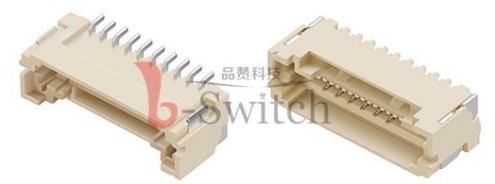

B

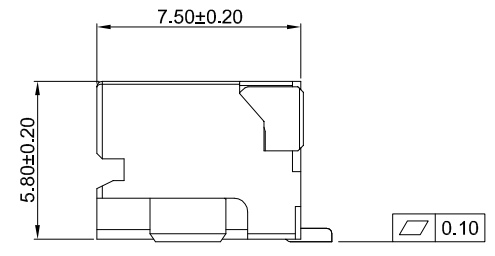
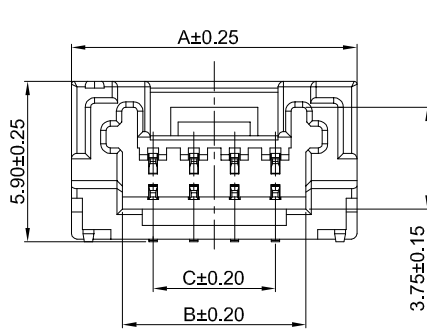

GT-A1504 W R S -1 XX X XX 01

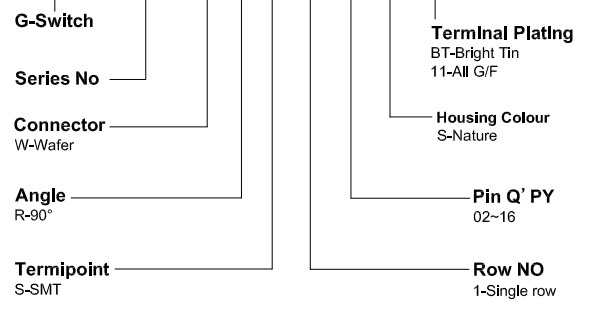

C

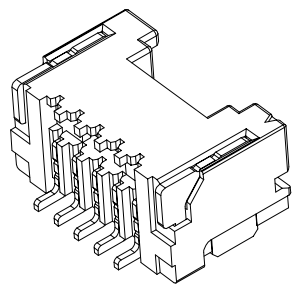
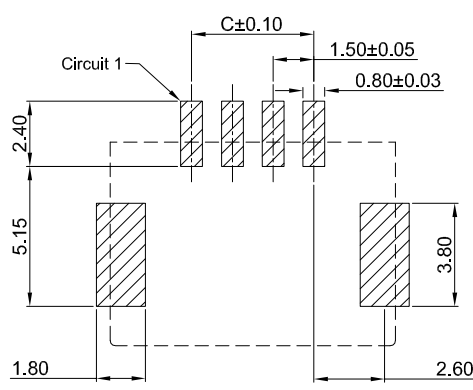

PCB REFERENCE DIAGRAM
TOLERANCE:±0.05

Ordering Information:

Circuit	Dimensions(mm)			Circuit	Dimensions(mm)		
	A	B	C		A	B	C
02	7.50	3.75	---	10	19.50	15.75	13.50
03	9.00	5.25	3.00	11	21.00	17.25	15.00
04	10.50	6.75	4.50	12	22.50	18.75	16.50
05	12.00	8.25	6.00	13	24.00	20.25	18.00
06	13.50	9.75	7.50	14	25.50	21.75	19.50
07	15.00	11.25	9.00	15	27.00	23.25	21.00
08	16.50	12.75	10.50	16	28.50	24.75	22.50
09	18.00	14.25	12.00	---	---	---	---

E

NO.	PART NAME	MATERIAL	REMARK
3	SOLDER TABS	BRASS	BRIGHT Tin
2	CONTACT	PHOSPHOR BRONZE	BRIGHT Tin or ALL G/F
1	HOUSING	PA9T, 94V-0	NATURE

SCALE: 1:1 UNIT: mm
SIZE: A4

Unless otherwise General Tolerance:
X ±0.40
X.x ±0.30
X.xx ±0.20
X* ±5°
X.x° ±3°

Title: Wafer 1.50mm Pitch 90° SMT Type Single Row Connector

Molde Code: GT-A1504WRS-1XXXXX01

DRAWN	CHECKED	APPROVED	DATE
Hu	Hu	Chen	2021.10.20



REV: A0 SHEET: 1/2



1

2

3

4

5

A

A

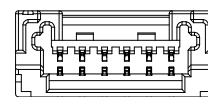
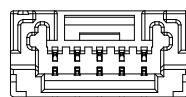
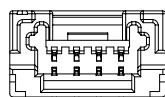
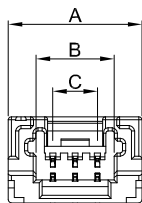
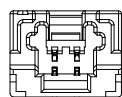

2PIN

3PIN

4PIN

5PIN

6PIN



B

B

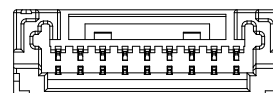
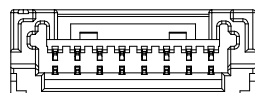
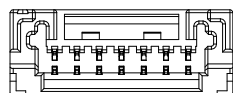

7PIN

8PIN

9PIN

C

C

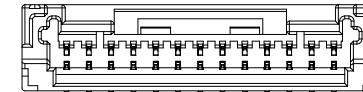
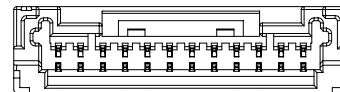
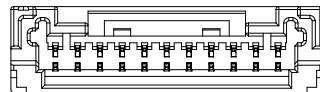
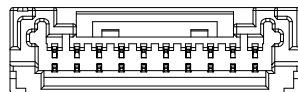

10PIN

11PIN

12PIN

13PIN

D

D

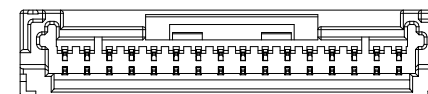
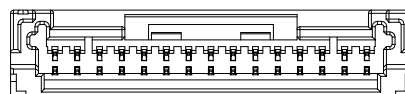
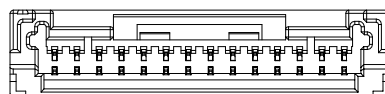

14PIN

15PIN

16PIN

E

E

3	SOLDER TABS	BRASS	BRIGHT Tin
2	CONTACT	PHOSPHOR BRONZE	BRIGHT Tin or ALL G/F
1	HOUSING	PA9T, 94V-0	NATURE
NO.	PART NAME	MATERIAL	REMARK



SCALE: 1:1 UNIT: mm
 SIZE: A4

Unless otherwise
 General Tolerance:
 X ±0.40
 X.x ±0.30
 X.xx ±0.20
 X° ±5°
 X.x° ±3°

Title: Wafer 1.50mm Pitch 90° SMT Type
 Single Row Connector

Molde Code: GT-A1504WRS-1XXXXX01

DRAWN	CHECKED	APPROVED	DATE
Hu	Hu	Chen	2021.10.20



REV: A0 SHEET: 2/2

1

2

3

4

5